

Prices
exclude
VAT



Arno Single

Height mm	Length mm	Henrad Code	UIN Colour*	Heat emissions		Henrad Price
				Watts	Btu/hr	
792	450	417902450	417902451	408	1392	£247.81
	500	417902500	417902501	452	1542	£278.45
	600	417902600	417902601	540	1842	£309.08
	750	417902750	417902751	672	2293	£339.70
1088	450	411002450	411002451	560	1911	£263.12
	500	411002500	411002501	615	2098	£293.76
	600	411002600	411002601	725	2474	£324.40
	750	411002750	411002751	890	3037	£355.01
1680	450	411602450	411602451	849	2897	£355.01
	500	411602500	411602501	929	3170	£387.04
	600	411602600	411602601	1090	3719	£417.66
	750	411602750	411602751	1331	4541	£448.30
1976	450	411902450	411902451	985	3361	£387.04
	500	411902500	411902501	1080	3685	£417.66
	600	411902600	411902601	1271	4337	£448.30
	750	411902750	411902751	1557	5312	£478.92

Btu/hr @ $\Delta t50^{\circ}\text{C}$

Arno Double

Height mm	Length mm	Henrad Code	UIN Colour*	Heat emissions		Henrad Price
				Watts	Btu/hr	
792	450	427902450	427902451	593	2023	£324.40
	500	427902500	427902501	657	2242	£355.01
	600	427902600	427902601	787	2685	£387.04
	750	427902750	427902751	982	3351	£417.66
1088	450	421002450	421002451	775	2644	£355.01
	500	421002500	421002501	860	2934	£387.04
	600	421002600	421002601	1030	3514	£417.66
	750	421002750	421002751	1287	4391	£448.30
1680	450	421602450	421602451	1200	4094	£463.62
	500	421602500	421602501	1327	4528	£494.24
	600	421602600	421602601	1583	5401	£524.87
	750	421602750	421602751	1967	6711	£556.89
1976	450	421902450	421902451	1409	4808	£509.55
	500	421902500	421902501	1556	5309	£541.57
	600	421902600	421902601	1852	6319	£572.20
	750	421902750	421902751	2296	7834	£602.85

Btu/hr @ $\Delta t50^{\circ}\text{C}$

Centre Tap TRV

Available from stock

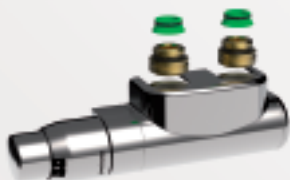

Working pressure:
Tested to withstand 6.0 bar



For technical and installation
information visit our website
www.henrad.co.uk/downloads



Centre Tap TRV is now available

Colour options available

Tube Dimensions



*Price of coloured radiators are available
on request.

When a coloured radiator has been ordered it cannot
be cancelled or returned. All coloured radiators have
up to an 8 week lead time from date of order.

Technical information

Testing and Operating Pressures

Henrad Arno Towel Rail Range has been independently tested to ensure radiators perform to a maximum working pressure of 6.0 bar.

Connections

Henrad Arno Towel Rail Range has 4 x 1/2" BSP connections as standard.

Paint Process

Two coat paint process, each Henrad radiator is subjected to a multi-stage cleaning and paint process.

The final powder coat is Traffic white (RAL A9016) which is stoved and cooled to give a perfect finish. All radiators are illustrated in Traffic white unless stated.

Colour Options

Colour options are available, see colour page.

Water Treatment

Installation of the system should be properly flushed and fitted in accordance with the British Code of Practice for the Treatment of Water in Domestic Hot Water Central Heating Systems.

Warranty

Henrad Arno Towel Rail Range come with a 5 year manufacturer's warranty.

Heating Element

Option available.

For more information contact the sales office on 0844 543 6200



Henrad (UK) Limited, Marriott Road,
Mexborough, South Yorkshire S64 8BN.
Telephone: 0844 543 6200 Facsimile: 0844 543 6300

www.henrad.co.uk

Arno Towel Rail Range

Arno Single

All dimensions in mm unless stated.

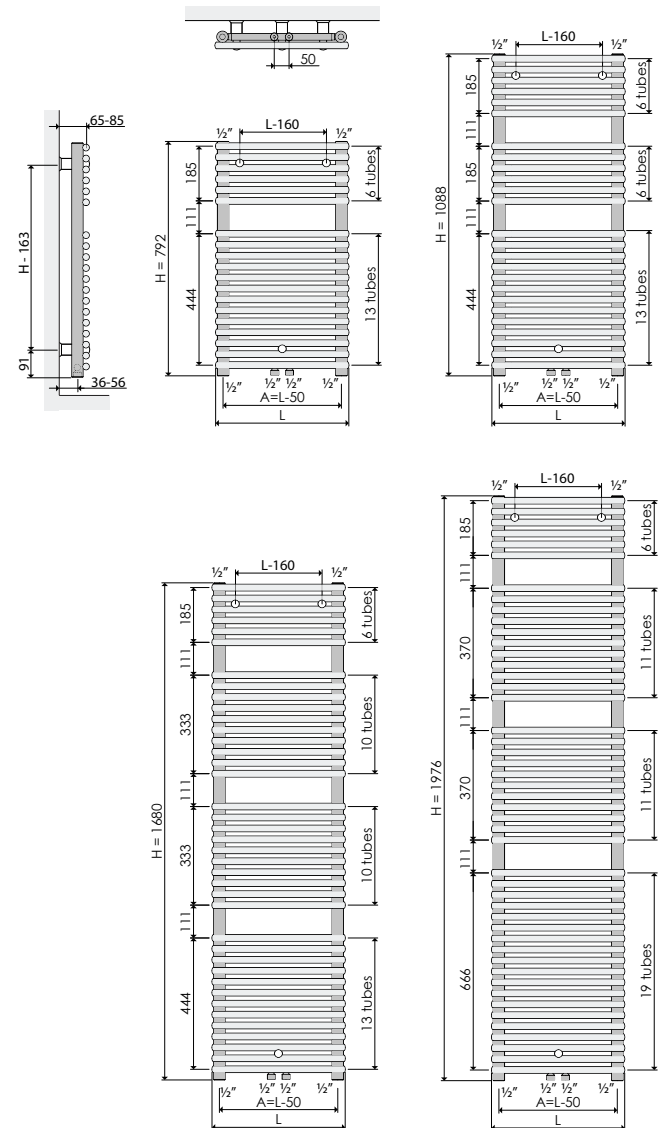

Arno Double

All dimensions in mm unless stated.

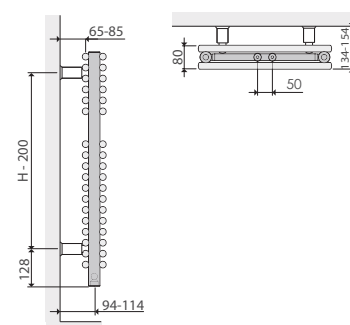

Colour Range

Natural Colour

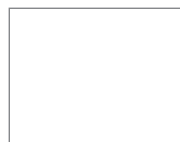

NT110
Papyrus white
510110

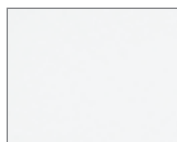

NT120
Pearl white
510120

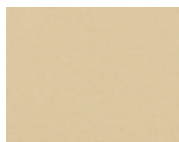

NT130
Champagne
510130

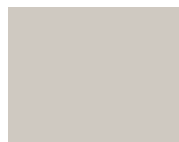

NT140
Beige
510140



NT150
Beige grey
510150

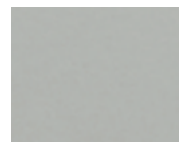

NT160
Pebble grey
510160



NT170
Quartz grey
510170



SN110
Cream white
530110



SN120
Cream
530120



SN130
Mocca
530130



SN140
Bordeaux
530140



SN150
Sepia
530150



SN160
Pale blue
530160



SN170
Black
530170

Metallic Colour



ML110
Dove grey
520110

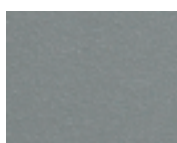

ML120
Titanium grey
520120

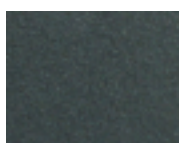

ML130
Blue grey
520130

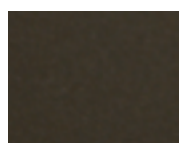

ML140
Granite
520140

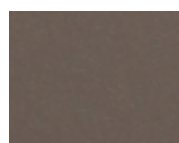

ML150
Cappuccino
520150

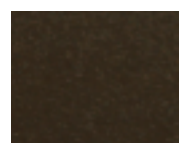

ML160
Terra brown
520160



ML170
Graphite black
520170

RAL Colour



A1004
Golden yellow
541004



A2003
Pastel orange
542003



A3002
Carmine red
543002



A3003
Robin red
543003



A5002
Ultramarine blue
545002



A6018
Yellow green
546018



A7001
Silver grey
547001



A7011
Iron grey
547011



A7016
Anthracite grey
547016



A7030
Stone grey
547030



A7035
Light grey
547035



A8017
Chocolate brown
548017



A9003
Signal white
549003



A9005
Jet black
549005

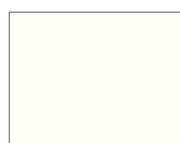

A9016
Traffic white



A7015
Slate grey
*Only available for
Column Concept

The colours shown throughout the brochure are reproduced as accurately as this process will allow and can be made to order on the identified products.

Price of coloured radiators are available on request. When a coloured radiator has been ordered it cannot be cancelled or returned. All coloured radiators have up to an 8 week lead time from date of order.